

▼ From left to right: RC2510, RC53, RC1002, RC108, RC5010, RC156



- Trio Bearing system with hardened composite wear bands for optimal side load resistance
- Strengthened Trio Stop Ring improves durability and side load resistance
- Trio Hybrid pre-tensioned spring system provides faster retraction
- High-grade polyethylene seals for low wear and long service life
- Plunger wiper reduces contamination, extending cylinder life.
- Collar and plunger threads and base mounting holes enable easy fixturing (on most models)
- Standard certified lifting eyes on cylinder models above 25 kg weight. Interchangeable with optional CHM6 carrying handle
- Designed for use in all positions
- Baked enamel finish for increased corrosion resistance
- Includes CR400 coupler, dust cap and collar thread protector
- RC-Series model numbers, external dimensions and threads remain unchanged from prior RC-Series cylinders

▼ *Foundation repair: to re-stabilize the foundation, the 308 ton silo needed to be lifted, levelled and structurally supported. 25 ton RC-Series hydraulic jacks were attached to a bracket on the top of each steel pier. Powered by a Z-Class pump, the hydraulic jacks applied 20 ton of force at each placement to lift the silo 5,1 cm.*



## The Industry Standard General Purpose Cylinder



### Saddles

All RC cylinders (except RC50 and RC101) have a hardened removable grooved saddle. For tilt and flat saddles, see the RC-Series accessory page. All CATS-Series Tilt Saddles use a nitrocarburization surface treatment for improved corrosion protection.

Page: 10



### Base Plates

To ensure the stability of cylinders for lifting applications, base plates are available for 10, 25 and 50 ton RC cylinders.

Page: 10



### Specialty Attachments

For solving all kinds of application problems, specialty attachments are available for 5, 10 and 25 ton RC cylinders.

Page: 176

▼ *Synchronous lifting set-up for 200 ton petrochemical process module using twelve RC2510 cylinders. To ensure the stability of the cylinders JBI25 base plates are installed.*



# Single-Acting, General Purpose Cylinders



## Optional Carrying Handle CHM6

Standard certified lifting eyes on cylinder models above 25 kg weight (RC5010 and heavier models). Interchangeable with optional carrying handle. Order model number **CHM6**.

▼ **QUICK SELECTION CHART** For complete technical information see next page.

Cylinder Capacity	Stroke	Model Number	Cylinder Effective Area	Oil Capacity	Collapsed Height	
ton (kN)	(mm)		(cm <sup>2</sup> )	(cm <sup>3</sup> )	(mm)	(kg)
<b>5</b> (45)	16	<b>RC50</b>	6,4	10	41	1,0
	25	<b>RC51</b>	6,4	16	110	1,0
	79	<b>RC53</b>	6,4	50	165	1,5
	127	<b>RC55 *</b>	6,4	83	216	1,9
	177	<b>RC57</b>	6,4	115	273	2,4
	232	<b>RC59</b>	6,4	151	324	2,8
<b>10</b> (101)	26	<b>RC101</b>	14,4	38	90	1,8
	54	<b>RC102 *</b>	14,4	78	121	2,3
	105	<b>RC104</b>	14,4	152	171	3,3
	156	<b>RC106 *</b>	14,4	226	248	4,4
	203	<b>RC108</b>	14,4	294	298	5,4
	257	<b>RC1010 *</b>	14,4	373	349	6,4
	304	<b>RC1012</b>	14,4	441	400	6,8
	356	<b>RC1014</b>	14,4	516	451	8,2
<b>15</b> (142)	25	<b>RC151</b>	20,3	51	124	3,3
	51	<b>RC152</b>	20,3	104	149	4,1
	101	<b>RC154 *</b>	20,3	205	200	5,0
	152	<b>RC156 *</b>	20,3	308	271	6,8
	203	<b>RC158</b>	20,3	411	322	8,2
	254	<b>RC1510</b>	20,3	516	373	9,5
	305	<b>RC1512</b>	20,3	619	424	10,9
	356	<b>RC1514</b>	20,3	723	475	11,8
<b>25</b> (232)	26	<b>RC251</b>	33,3	86	140	5,9
	50	<b>RC252 *</b>	33,3	166	165	6,4
	102	<b>RC254 *</b>	33,3	339	216	8,2
	158	<b>RC256 *</b>	33,3	525	273	10,0
	210	<b>RC258</b>	33,3	697	324	12,2
	261	<b>RC2510</b>	33,3	867	375	14,1
	311	<b>RC2512</b>	33,3	1033	425	16,3
	362	<b>RC2514 *</b>	33,3	1202	476	17,7
<b>30</b> (295)	209	<b>RC308</b>	42,9	880	387	18,1
<b>50</b> (498)	51	<b>RC502</b>	71,3	362	176	15,0
	101	<b>RC504</b>	71,3	719	227	19,1
	159	<b>RC506 *</b>	71,3	1131	283	23,1
	260	<b>RC5010</b>	71,3	1855	384	31,8
	337	<b>RC5013</b>	71,3	2399	460	37,6
<b>75</b> (718)	156	<b>RC756</b>	102,6	1601	286	29,5
	333	<b>RC7513</b>	102,6	3417	492	59,0
<b>95</b> (933)	50	<b>RC1002</b>	133,1	676	219	36,7
	168	<b>RC1006</b>	133,1	2239	357	59,0
	260	<b>RC10010</b>	133,1	3466	449	72,6

\* Available as set, see note on this page.

## RC-Trio Series



Capacity:  
**5 - 95 ton**

Stroke:  
**16 - 362 mm**

Maximum Operating Pressure:  
**700 bar**



### Think Safety

Manufacturer's rating of load and stroke are maximum safe limits. Good practice encourages using only 80% of these ratings.

Page: **396**



### Lightweight Aluminium Cylinders

If you need a higher cylinder capacity-to-weight-ratio the **RAC-Series** are the perfect choice.

Page: **13**



### Gauges

Minimize the risk of overloading and ensure long, dependable service from your equipment. Refer to the System Components

Section for a full range of gauges.

Page: **127**

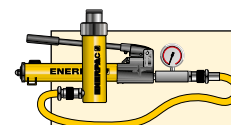

### Cylinder-Pump Sets

All cylinders marked with an \* are available as **sets** (cylinder, gauge, couplers, hose and pump) for your ordering convenience.

Page: **62**

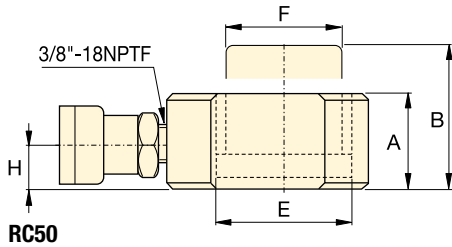
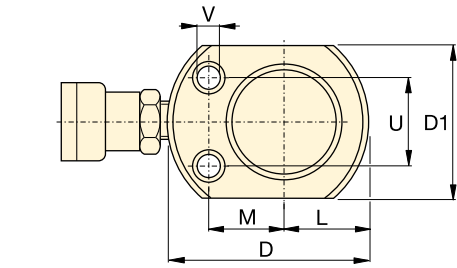

**RC50**

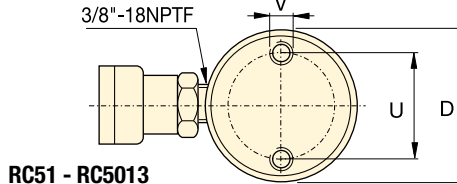
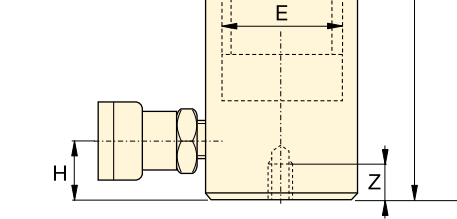
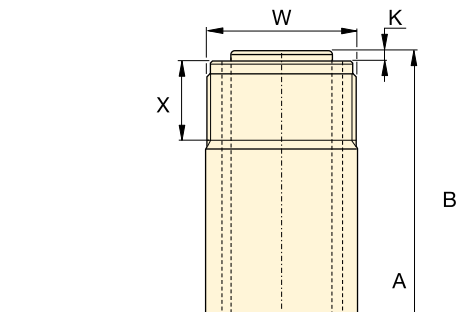
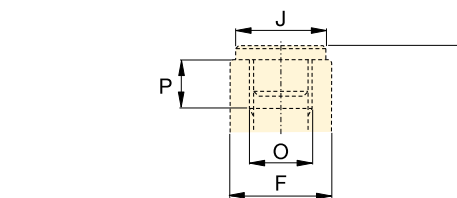
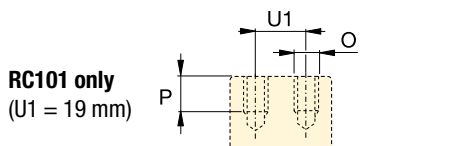

**RC51 - RC5013**

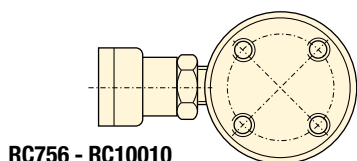

**RC756 - RC10010**



### Speed Chart and Pump Selection Tool

See the Enerpac Cylinder Speed Chart in our 'Yellow Pages' to determine your approximate cylinder speed. See Pump Selection Tool on website for help to choose the most suitable pump for your application.

Page: **405**

◀ For full features see previous page.

Cylinder Capacity	Stroke	Model Number	Cylinder Effective Area	Oil Capacity	Collapsed Height	Extended Height	Outside Dia.
ton (kN)	(mm)		(cm <sup>2</sup> )	(cm <sup>3</sup> )	A (mm)	B (mm)	D (mm)
<b>5 (45)</b>	16	<b>RC50</b> <sup>2)</sup>	6,4	10	41	57	58 <sup>3)</sup>
	25	<b>RC51</b>	6,4	16	110	135	38
	79	<b>RC53</b>	6,4	50	165	244	38
	127	<b>RC55</b> <sup>1)</sup>	6,4	83	216	343	38
	177	<b>RC57</b>	6,4	115	273	450	38
	232	<b>RC59</b>	6,4	151	324	556	38
<b>10 (101)</b>	26	<b>RC101</b> <sup>4)</sup>	14,4	38	90	116	57
	54	<b>RC102</b> <sup>1)</sup>	14,4	78	121	175	57
	105	<b>RC104</b>	14,4	152	171	276	57
	156	<b>RC106</b> <sup>1)</sup>	14,4	226	248	404	57
	203	<b>RC108</b>	14,4	294	298	501	57
	257	<b>RC1010</b> <sup>1)</sup>	14,4	373	349	606	57
	304	<b>RC1012</b>	14,4	441	400	704	57
	356	<b>RC1014</b>	14,4	516	451	807	57
<b>15 (142)</b>	25	<b>RC151</b>	20,3	51	124	149	70
	51	<b>RC152</b>	20,3	104	149	200	70
	101	<b>RC154</b> <sup>1)</sup>	20,3	205	200	301	70
	152	<b>RC156</b> <sup>1)</sup>	20,3	308	271	423	70
	203	<b>RC158</b>	20,3	411	322	525	70
	254	<b>RC1510</b>	20,3	516	373	627	70
	305	<b>RC1512</b>	20,3	619	424	729	70
	356	<b>RC1514</b>	20,3	723	475	831	70
<b>25 (232)</b>	26	<b>RC251</b>	33,3	86	140	166	86
	50	<b>RC252</b> <sup>1)</sup>	33,3	166	165	215	86
	102	<b>RC254</b> <sup>1)</sup>	33,3	339	216	318	86
	158	<b>RC256</b> <sup>1)</sup>	33,3	525	273	431	86
	210	<b>RC258</b>	33,3	697	324	534	86
	261	<b>RC2510</b>	33,3	867	375	636	86
	311	<b>RC2512</b>	33,3	1033	425	736	86
	362	<b>RC2514</b> <sup>1)</sup>	33,3	1202	476	838	86
<b>30 (295)</b>	209	<b>RC308</b>	42,9	880	387	596	102
<b>50 (498)</b>	51	<b>RC502</b>	71,3	362	176	227	127
	101	<b>RC504</b>	71,3	719	227	328	127
	159	<b>RC506</b> <sup>1)</sup>	71,3	1131	283	442	127
	260	<b>RC5010</b>	71,3	1855	384	644	127
	337	<b>RC5013</b>	71,3	2399	460	797	127
<b>75 (718)</b>	156	<b>RC756</b>	102,6	1601	286	442	146
	333	<b>RC7513</b>	102,6	3417	492	825	146
<b>95 (933)</b>	51	<b>RC1002</b>	133,1	676	219	270	178
	168	<b>RC1006</b>	133,1	2239	357	525	178
	260	<b>RC10010</b>	133,1	3466	449	709	178

<sup>1)</sup> Available as set, see note on page 7.

<sup>2)</sup> RC50 cylinder has a non removable grooved saddle and no collar thread.

<sup>3)</sup> RC50: D1 = 41 mm, L = 20 mm, M = 25 mm.

<sup>4)</sup> RC101 has plunger with two thread holes and non-removable saddle.

# Single-Acting, General Purpose Cylinders

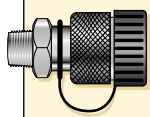

## Couplers Included!

CR-400 couplers included on all models. Fits all HC-Series hoses.

Capacity:

**5 - 95 ton**

Stroke:

**16 - 362 mm**

Maximum Operating Pressure:

**700 bar**

## RC-Trio Series



Cylinder Bore Dia. E (mm)	Plunger Dia. F (mm)	Base to Adv. Port H (mm)	Saddle Dia. J (mm)	Saddle Protr. from Plgr. K (mm)	Plunger Internal Thread O	Plunger Thread Length P (mm)	Base Mounting Holes			Collar Thread W	Collar Thread Length X (mm)	 (kg)	Model Number
							Bolt Circle U (mm)	Thread V	Thd. Depth Z (mm)				
28,6	25,4	19	2)	2)	2)	2)	29	5,6 mm	—	—	—	1,0	RC50 <sup>2)</sup>
28,6	25,4	19	25	6	3/4" - 16 UN	14	25	1/4" - 20 UNC	14	1 1/2" - 16 UN	28	1,0	RC51
28,6	25,4	19	25	6	3/4" - 16 UN	14	25	1/4" - 20 UNC	14	1 1/2" - 16 UN	28	1,5	RC53
28,6	25,4	19	25	6	3/4" - 16 UN	14	25	1/4" - 20 UNC	14	1 1/2" - 16 UN	28	1,9	RC55 <sup>1)</sup>
28,6	25,4	19	25	6	3/4" - 16 UN	16	25	1/4" - 20 UNC	14	1 1/2" - 16 UN	28	2,4	RC57
28,6	25,4	19	25	6	3/4" - 16 UN	16	25	1/4" - 20 UNC	14	1 1/2" - 16 UN	28	2,8	RC59
42,8	38,1	19	—	—	#10 - 24 UN	6	40	5/16" - 18 UNC	12	2 1/4" - 14 UN	27	1,8	RC101 <sup>4)</sup>
42,8	38,1	19	35	6	1" - 8 UN	19	40	5/16" - 18 UNC	12	2 1/4" - 14 UN	27	2,3	RC102 <sup>1)</sup>
42,8	38,1	19	35	6	1" - 8 UN	19	40	5/16" - 18 UNC	12	2 1/4" - 14 UN	27	3,3	RC104
42,8	38,1	19	35	6	1" - 8 UN	19	40	5/16" - 18 UNC	12	2 1/4" - 14 UN	27	4,4	RC106 <sup>1)</sup>
42,8	38,1	19	35	6	1" - 8 UN	19	40	5/16" - 18 UNC	12	2 1/4" - 14 UN	27	5,4	RC108
42,8	38,1	19	35	6	1" - 8 UN	19	40	5/16" - 18 UNC	12	2 1/4" - 14 UN	27	6,4	RC1010 <sup>1)</sup>
42,8	38,1	19	35	6	1" - 8 UN	19	40	5/16" - 18 UNC	12	2 1/4" - 14 UN	27	6,8	RC1012
42,8	38,1	19	35	6	1" - 8 UN	19	40	5/16" - 18 UNC	12	2 1/4" - 14 UN	27	8,2	RC1014
50,8	41,3	19	38	9	1" - 8 UN	25	48	3/8" - 16 UNC	12	2 3/4" - 16 UN	30	3,3	RC151
50,8	41,3	19	38	9	1" - 8 UN	25	48	3/8" - 16 UNC	12	2 3/4" - 16 UN	30	4,1	RC152
50,8	41,3	19	38	9	1" - 8 UN	25	48	3/8" - 16 UNC	12	2 3/4" - 16 UN	30	5,0	RC154 <sup>1)</sup>
50,8	41,3	25	38	9	1" - 8 UN	25	48	3/8" - 16 UNC	12	2 3/4" - 16 UN	30	6,8	RC156 <sup>1)</sup>
50,8	41,3	25	38	9	1" - 8 UN	25	48	3/8" - 16 UNC	12	2 3/4" - 16 UN	30	8,2	RC158
50,8	41,3	25	38	9	1" - 8 UN	25	48	3/8" - 16 UNC	12	2 3/4" - 16 UN	30	9,5	RC1510
50,8	41,3	25	38	9	1" - 8 UN	25	48	3/8" - 16 UNC	12	2 3/4" - 16 UN	30	10,9	RC1512
50,8	41,3	25	38	9	1" - 8 UN	25	48	3/8" - 16 UNC	12	2 3/4" - 16 UN	30	11,8	RC1514
65,1	57,2	25	51	10	1 1/2" - 16 UN	25	59	1/2" - 13 UNC	19	3 5/16" - 12 UN	49	5,9	RC251
65,1	57,2	25	51	10	1 1/2" - 16 UN	25	59	1/2" - 13 UNC	19	3 5/16" - 12 UN	49	6,4	RC252 <sup>1)</sup>
65,1	57,2	25	51	10	1 1/2" - 16 UN	25	59	1/2" - 13 UNC	19	3 5/16" - 12 UN	49	8,2	RC254 <sup>1)</sup>
65,1	57,2	25	51	10	1 1/2" - 16 UN	25	59	1/2" - 13 UNC	19	3 5/16" - 12 UN	49	10,0	RC256 <sup>1)</sup>
65,1	57,2	25	51	10	1 1/2" - 16 UN	25	59	1/2" - 13 UNC	19	3 5/16" - 12 UN	49	12,2	RC258
65,1	57,2	25	51	10	1 1/2" - 16 UN	25	59	1/2" - 13 UNC	19	3 5/16" - 12 UN	49	14,1	RC2510
65,1	57,2	25	51	10	1 1/2" - 16 UN	25	59	1/2" - 13 UNC	19	3 5/16" - 12 UN	49	16,3	RC2512
65,1	57,2	25	51	10	1 1/2" - 16 UN	25	59	1/2" - 13 UNC	19	3 5/16" - 12 UN	49	17,7	RC2514 <sup>1)</sup>
73,0	57,2	29	51	10	1 1/2" - 16 UN	25	59	1/2" - 13 UNC	16	3 5/16" - 12 UN	49	18,1	RC308
95,2	79,4	33	71	2	—	—	95	1/2" - 13 UNC	19	5" - 12 UN	55	15,0	RC502
95,2	79,4	33	71	2	—	—	95	1/2" - 13 UNC	19	5" - 12 UN	55	19,1	RC504
95,2	79,4	35	71	2	—	—	95	1/2" - 13 UNC	19	5" - 12 UN	55	23,1	RC506 <sup>1)</sup>
95,2	79,4	35	71	2	—	—	95	1/2" - 13 UNC	19	5" - 12 UN	55	31,8	RC5010
95,2	79,4	35	71	2	—	—	95	1/2" - 13 UNC	19	5" - 12 UN	55	37,6	RC5013
114,3	95,3	30	71	2	—	—	114	5/8" - 13 UNC	16	5 3/4" - 12 UN	44	29,5	RC756
114,3	95,3	30	71	2	—	—	114	5/8" - 13 UNC	16	5 3/4" - 12 UN	44	59,0	RC7513
130,2	104,8	41	71	2	—	—	140	3/4" - 10 UNC	25	6 7/8" - 12 UN	44	36,7	RC1002
130,2	104,8	41	71	2	—	—	140	3/4" - 10 UNC	25	6 7/8" - 12 UN	44	59,0	RC1006
130,2	104,8	41	71	2	—	—	140	3/4" - 10 UNC	25	6 7/8" - 12 UN	44	72,6	RC10010



## SELECTION CHART

For use with Cylinder Capacity ton (kN)	Saddles			Base Plate	Mounting Block	Clevis Eyes	
	Flat	Grooved <sup>1)</sup>	Tilt			Base <sup>4)</sup>	Plunger
5 (45)	A53F <sup>2)</sup>	A53G <sup>2)</sup>	-	-	RB5 <sup>2)</sup> , AW51 <sup>2)</sup> , AW53 <sup>2)</sup>	REB5 <sup>2)</sup>	REP5 <sup>2)</sup>
10 (101)	A12 <sup>3)</sup> , A102F <sup>3)</sup>	A102G <sup>3)</sup>	CATS12 <sup>3)</sup>	JB110 <sup>3)</sup>	RB10, AW102	REB10	REP10 <sup>3)</sup>
15 (142)	-	A152G	CATS12	-	RB15	REB15	REP10
25 (232)	A29 <sup>5)</sup>	A252G	CATS52	JB125	RB25	REB25	REP25
30 (295)	A29 <sup>5)</sup>	A252G	CATS52	-	RB25	-	REP25
50 (498)	-	-	CATS100	JB150	-	-	-
75 (718)	-	-	CATS100	-	-	-	-
95 (933)	-	-	CATS100	-	-	-	-

<sup>1)</sup> Standard on 5-30 ton RC-cylinders   <sup>2)</sup> Except RC50   <sup>3)</sup> Except RC101   <sup>4)</sup> Mounting screws are included.   <sup>5)</sup> Used with Bender Sets.

## DIMENSION CHARTS

Model Number	Saddle Dimensions (mm)			A53F, A102F A12, A29	For Cylinder Capacity ton (kN)	Tilt Saddle Model Number	Addition to Collapsed Height A1 (mm)	Saddle Diameter J1 (mm)	
	A	B	C						
<b>Flat</b>					10 (101)	CATS12	14	35	
A53F	25	6	17	15 (142)	CATS12	11	35		
A102F	35	6	22	25 (232)	CATS52	15	50		
A12	51	48	1"-8 UNC	30 (295)	CATS52	15	50		
<b>Grooved</b>					50 (498)	CATS100	15	71	
A53G	25	6	17	75 (718)	CATS100	15	71		
A102G	35	6	22	95 (933)	CATS100	15	71		
A152G	38	9	22						
A252G	50	9	35						

Model Number	Base Plate Dimensions (mm)						
	A	B	C	D	E		
JB110	228	228	135	58	20		
JB125	279	279	140	86	26		
JB150	304	15	95	131	31		

Model Number	Mounting Block Dimensions (mm)											
	A	B	C	D	E	F	G	H				
RB5	1 1/2" -16UN	88	76	-	25	-	-	-				
AW51	1 1/2" -16UN	70	59	10	24	54	1/4" -16 UN	41				
AW53	1 1/2" -16UN	72	7	7	19	57	1/4" -20 UN	10				
RB10	2 1/4" -14UN	114	88	-	25	-	-	-				
AW102	2 1/4" -14UN	100	82	16	30	76	7/16" -20 UN	58				
RB15	2 3/4" -16UN	101	114	-	38	-	-	-				
RB25	3 5/16" -12UN	127	165	-	50	-	-	-				

Type	Model Number	Clevis Eye Dimensions (mm)						Pin-to-Pin * (mm)		
		A	B	C	D	E	F			
Base <sup>4)</sup>	REB5	44	47	14	16	16	25	60,2		
	REB10	63	66	25	22	25	35	78,0		
	REB15	76	66	25	22	25	35	78,0		
	REB25	95	79	38	31	31	41	87,6		
Plunger	REP5	28	45	14	16	16	19	-		
	REP10	42	61	25	22	25	28	-		
	REP25	57	71	38	31	31	35	-		

<sup>4)</sup> Mounting screws are included.

\* Pin to Pin – REB and REP Clevises fitted. Add cylinder collapsed height.